



**Best under pressure:**  
*The pressure-resistant  
AxiEco axial fan.*

Sizes 630, 800, and 910 mm.

**ebmpapst**

engineering a better life

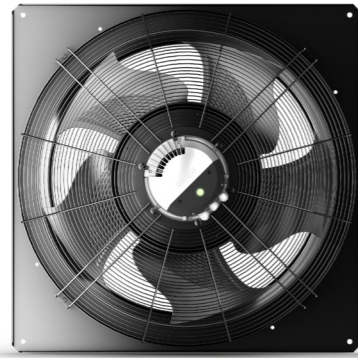

# Developed for the most stringent requirements.

By the time the next ErP stage (EU Energy-related Products Directive) comes into force, at the latest, the AC axial fans still in widespread use may have already reached their limits and will not meet the high efficiency requirements.

With AxiEco, ebm-papst has succeeded in developing an axial fan that is perfectly adapted to the requirements of flash freezers, chillers, evaporators, condensers, control cabinet and generator cooling systems, and numerous other applications.

The EC version delivers impressive robustness, powerful performance, low noise levels and economical operation.

Its hallmark: BEST UNDER PRESSURE. In other words, when the AxiEco is under significant pressure, it really shows what it can do. It is particularly effective against high back pressures in ventilation, air conditioning and refrigeration applications.

What exactly does that mean for individual sectors and applications? Let us tell you:

## Top performance *under pressure*: AxiEco.

In ventilation, air conditioning, refrigeration and industrial engineering, the ambient conditions are harsh. Address them effectively with AxiEco:



Air flow above 25,000 m<sup>3</sup>/h, static pressure above 700 Pa



Pleasantly quiet



Reliable in use over the long term



Robust against environmental influences

Consistently withstanding pressure and ice formation: the AxiEco in refrigeration technology.



The AxiEco exhibits one of its major strengths in evaporator applications. If ice forms on the heat exchanger, the axial fan works with high efficiency for longer despite the increasing back pressure. The reason for this is its improved flow machine, which has a much steeper characteristic curve than usual, resulting in an extended evaporator service life, fewer defrosting cycles and a better overall system efficiency. The AxiEco's innovative design also helps the guard grill to freeze more slowly and the blades do not freeze on.

Conquering new power ranges: the AxiEco in ventilation and air conditioning technology.



Thanks to aerodynamic optimizations, the AxiEco's air performance curve is steeper than that of comparable axial fans. This means that it covers a significantly larger power range and still operates at optimum efficiency even with increasing back pressure. A great advantage for ventilation and air conditioning is that fewer fans are required to generate the same power. The reason for this is the power density: the AxiEco achieves a higher air performance per area. It is also robust in construction and helps outdoor chillers, for example, to perform at their best.

Ensuring resilience: the AxiEco in data centers.



The demands on data center performance are constantly increasing. The AxiEco is up to the task: with its powerful air performance, it cools the highly sensitive electronics reliably, quietly, and with high efficiency around the clock. The robust design with basket guard grill and inlet ring made of steel with surface coating is particularly advantageous for external circuits that are directly exposed to environmental influences such as humidity and temperature fluctuations. As an option, the relevant version is even suitable for particularly aggressive salt spray.

# Conquering new *power ranges*.

With its AxiEco, ebm-papst has developed a powerful axial fan that delivers impressively enhanced performance values. Its air performance curve points steeply upwards. In terms of efficiency and pressure stability, no comparable axial fans come close to it.

Good to know: its robust design with basket guard grill means that the AxiEco is well protected against influences such as humidity. It is supplied as a complete plug & play solution, including CE marking, which can be used quickly, flexibly and easily in numerous applications.

## Fan housing with inlet ring

- Pre-assembled inlet ring**
- + Optimum flow
  - + Immersed into the impeller

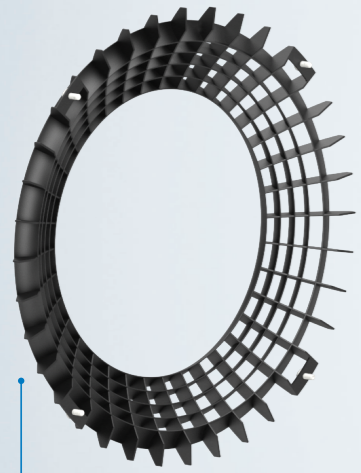

## FlowGrid (optional)

### Reduced noise spectrum

- + Low noise level
- + Dramatically dampened blade passing noise
- + Without loss of air performance or efficiency

### Compact design

- + Minimal space requirement
- + Fewer insulation measures

### Quick installation

- + Through-holes for easy attachment
- + Customized attachments on request

### Robust design

- + Resistant composite material
- + Optionally as a closed version with guard grill function

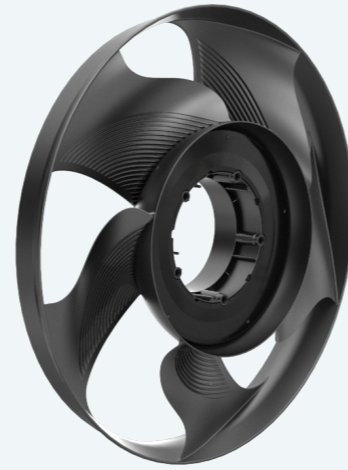

## Impeller

### Innovative impeller

- + With diffuser ring and internal diffuser

### Increased power density

- + Improved mechanical stability due to grooved blades
- + Three-dimensional blade shape

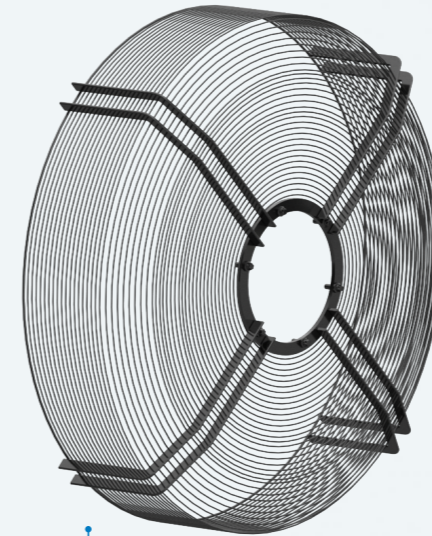

## Guard grill

### Safe operation

- + Guard grill according to DIN EN ISO 13857 standard

### Noise reduction

- + Minimal loss of air performance or efficiency

### Robust design

- + Hot-dip galvanized steel components
- + Guard grill made of steel and coated with black plastic



## Electronics and connection area

### Adaptable

- + Configurable control interface
- + Control signal 0–10 VDC and MODBUS-RTU
- + Smoothly adjustable speed

### Universally deployable

- + For use with 50 and 60-Hz grids

### Increased operational reliability

- + Integrated locked-rotor and thermal overload protection
- + Environment-resistant cable glands

### Simple commissioning

- + Central terminal area separated from electronics
- + No programming effort

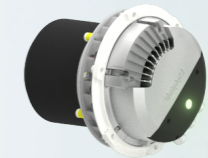

## GreenTech EC motor

### Unbeatably compact

- + Impeller directly on motor rotor

### High efficiency

- + Low copper and iron losses
- + Synchronous running prevents slip losses
- + No magnetic hysteresis losses

### Economical operation

- + Partial-load operation up to 1:10 at high efficiency

### Long service life

- + Maintenance-free bearings
- + Brushless commutation

### Safe operation

- + Insulated bearing system

### Sustainable

- + Magnets without use of rare earths



# Performance *in view.*

### Robust guard grill

The AxiEco guard grill is made of metal, which makes it extremely stable and resistant to heavy loads.

### Increased efficiency thanks to pressure-boosting diffuser

The AxiEco integrated diffuser ring is integrated directly into the impeller, where it functions as a diffuser. This means that the impeller has the largest outflow angle possible. By increasing the pressure, the diffuser reduces outlet losses and increases the fan's efficiency. The diffuser also helps to reduce the noise.

### Optimum flow thanks to improved impeller geometry

The blade shape has undergone three-dimensional improvements and the impeller has been optimized in accordance with the latest findings in aerodynamics. The fan has an optimal throughflow thanks to the inlet ring that immerses in the impeller and thanks to the larger outlet opening.

### No freezing on the nozzle due to absence of a tip gap

There is no tip gap between the fan housing and the impeller on the AxiEco. The impeller, integrated diffuser ring and hub form a compact unit, with the blade tips passing directly into the integrated diffuser ring. This has several advantages: there is no overflow of the blade tips, but rather increased efficiency and improved noise behavior. As a result, the blades can no longer freeze on the fan housing.

### Higher power density thanks to blades with grooves on the rear

The AxiEco's fan blades have grooves. This increases its mechanical stability, in turn enabling a higher power density.

# Questions and answers about the AxiEco.



## What requirements does the AxiEco cover?

Due to its low noise emission, the AxiEco is well suited for applications in noise-sensitive areas. With air flows above 25,000 m<sup>3</sup>/h and pressures above 700 Pa, its range of applications is broad, from chillers and evaporators to industrial process cooling and data centers.

## What makes the outflow characteristics of the AxiEco so special?

The AxiEco is characterized by its improved flow profile, among other things. This is best shown when comparing it to the flow profile of a common axial fan:

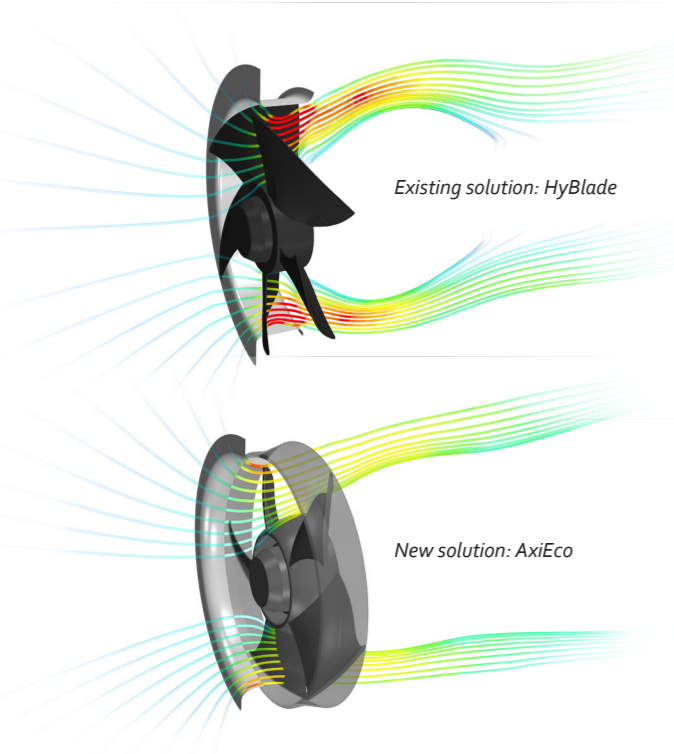

While the air flow of other axial fans spreads outwards, the outflow characteristic of the AxiEco series remains "on course" for longer, even when there are higher back pressures, and retains an axial direction. The flow direction remains constant and the air in the interior is therefore not taken in again.



## How does the AxiEco fight off ice formation?

Ice formation particularly afflicts evaporators if the humidity precipitates on the heat exchanger as ice at cold ambient temperatures. This means that the air path is restricted and the pressure increases. At higher back pressures, the AxiEco offers significantly more pressure reserves than other fans. This extends the intervals between defrosting cycles and means that the refrigerating plant can be operated more efficiently for longer periods. In addition, the impeller in the AxiEco has no tip gap, meaning that it is unlikely to freeze up. What's more, its impeller with integrated diffuser ring has been produced in highly resistant plastic, a material that discourages icing in and of itself.



## Why is the AxiEco's high power density advantageous?

Since the AxiEco can be operated at higher speeds, it achieves a higher air performance per area. Compared to other axial fans, this means that fewer fans are required to deliver the same performance. This not only increases the overall efficiency, but also saves space.



## How does the AxiEco increase efficiency?

There will be more stringent requirements for the efficiency of fans by the time the next stage of the ErP comes into force. The AxiEco already meets these requirements with ease. For example, it offers a significant increase in efficiency compared to the HyBlade with full nozzle.



## Why is the AxiEco so incredibly quiet?

The main reason behind this is that the impeller, integrated diffuser ring and hub form a compact unit. The blade tips seamlessly join the integrated diffuser ring so there is no longer any tip gap between the fan housing and the impeller. This results in hardly any turbulence in the edge area – and therefore also less noise. The integrated diffuser also helps to reduce noise, meaning that the noise level remains pleasantly low even at higher pressure ranges.

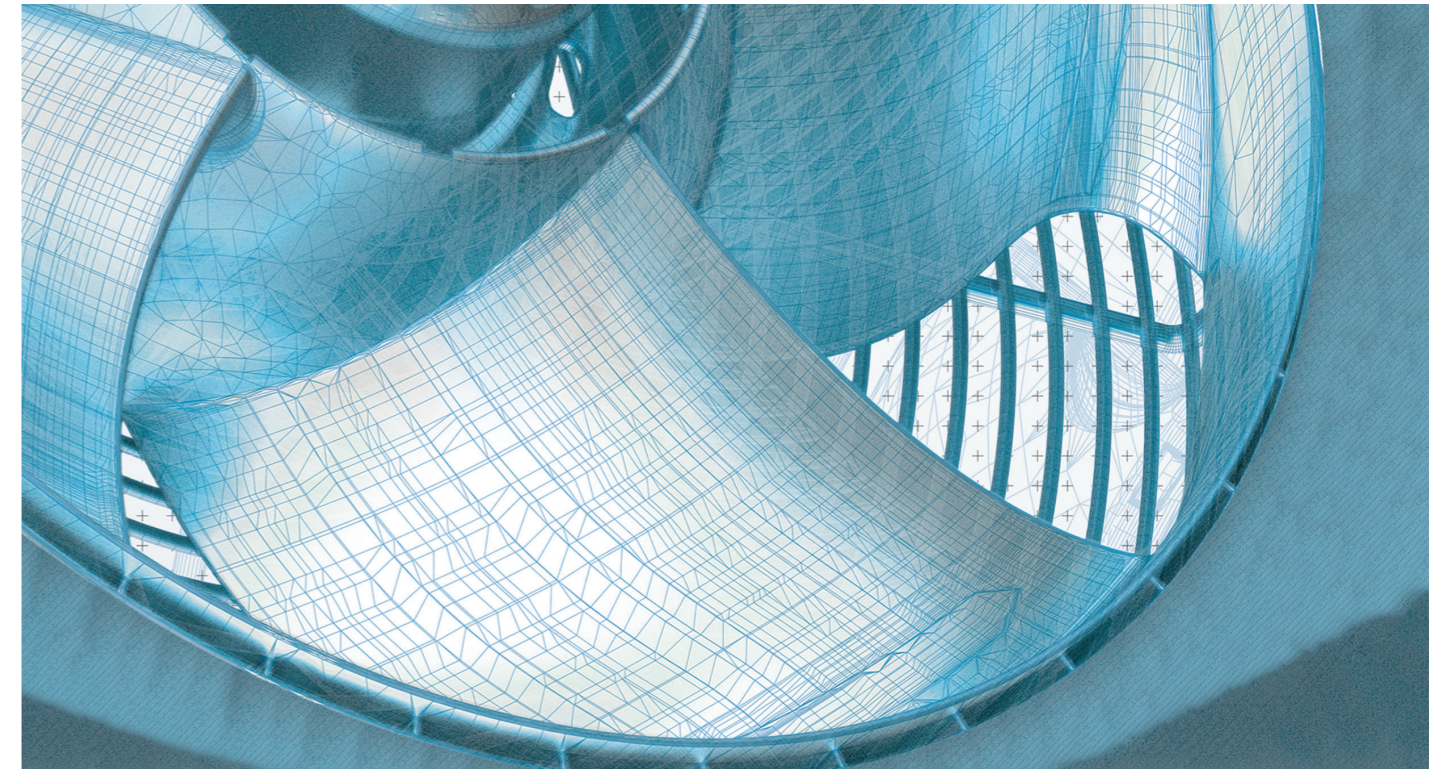

## How do I benefit from the AxiEco's ErP conformity?

In the next stage of the ErP Directive (Energy-related Products Directive), the EU is stipulating mandatory minimum efficiency levels for fans. A device will only be able to bear the CE label if it fulfills the required standard values. With the AxiEco, manufacturers are on the safe side in this respect and thus ideally equipped for the future, as the axial fan fully complies with the new ErP requirements. Its efficiency is significantly better than previous axial fans, making its operation much more efficient.

## Is the AxiEco also available in other sizes?

Yes, the AxiEco is also available in sizes 300-500. Please do not hesitate to ask us about this if you need to.



## What are the advantages of using EC motor technology?

AxiEco meets the requirements of the next ErP stage with the motor technology used. EC technology also offers additional benefits, such as:

- Better efficiency than AC motors
- Lower energy consumption and, therefore, less waste heat
- Demand-based control via a 0 to 10 V signal
- Control and monitoring via MODBUS RTU
- High efficiency and low energy consumption in partial-load operation
- High EC motor speeds permit much better air performance

If you have any further questions, you can contact us at any time. Please contact: +49 7938 81-0 or [info1@de.ebmpapst.com](mailto:info1@de.ebmpapst.com), [ebmpapst.com/axieco](http://ebmpapst.com/axieco)

# AxiEco with fan housing.

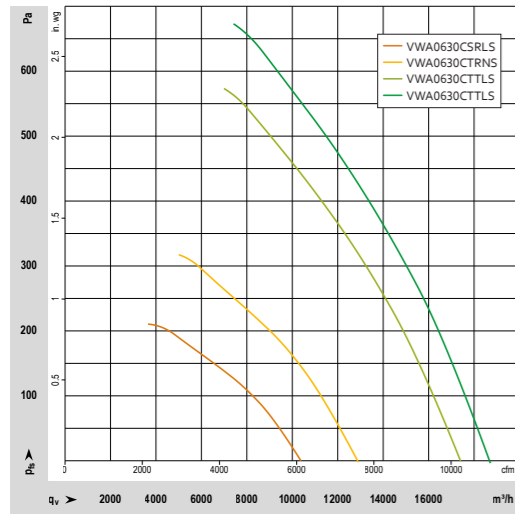

Characteristic curve field for size 630 (measured without fan housing)

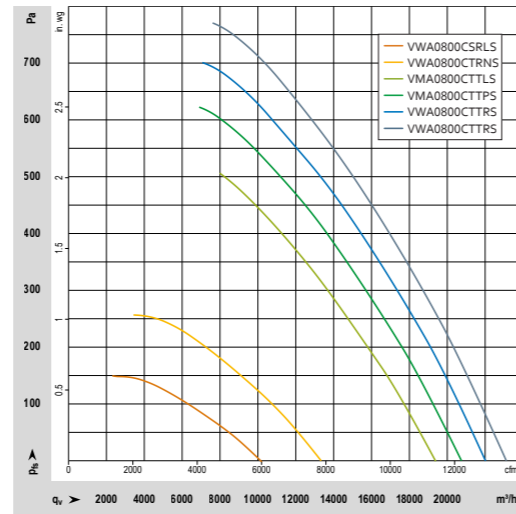

Characteristic curve field for size 800 (measured without fan housing)

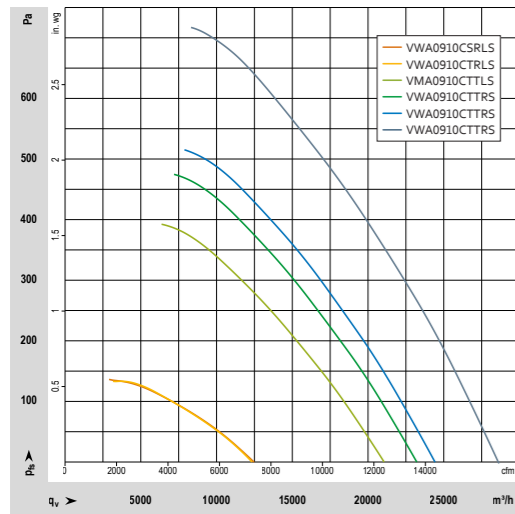

Characteristic curve field for size 910 (measured without fan housing)

Nominal data			Nominal voltage range	Frequency	Speed <sup>(1)</sup>	Max. power consumption <sup>(1)</sup>	Max. input current <sup>(1)</sup>	Permiss. ambient temp.
Size	Type	Material number	V AC	Hz	rpm	W	A	°C
630	VWA0630CSRLS	8300100196	1-200-277	50/60	1,010	600	2.65	-40...+60
	VWA0630CTRNS	8300100195	3-380-480	50/60	1,250	1,100	1.7	-40...+60
	VWA0630CTTLS	8300100293	3-200-240	50/60	1,690	2,750	8.3	-40...+60
	VWA0630CTTRS	8300100237	3-380-480	50/60	1,830	3,400	5.2	-40...+60
800	VWA0800CSRLS	8300100231	1-200-277	50/60	660	380	1.7	-40...+60
	VWA0800CTRNS	8300100230	3-380-480	50/60	870	840	1.3	-40...+60
	VMA0800CTTLS	8300100240	3-380-480	50/60	1,270	2,500	3.9	-40...+60
	VMA0800CTTPS	8300100253	3-380-480	50/60	1,370	3,150	4.8	-40...+60
	VWA0800CTTRS	8300100292	3-200-240	50/60	1,450	3,700	11.5	-40...+60
	VWA0800CTTRS	8300100272	3-380-480	50/60	1,520	4,300	6.8	-40...+60
910	VWA0910CSRLS	8300100236	3-380-480	50/60	570	420	0.7	-40...+60
	VWA0910CTRNS	8300100234	3-380-480	50/60	570	420	0.7	-40...+60
	VMA0910CTTLS	8300100251	3-380-480	50/60	970	2,000	3.1	-40...+60
	VWA0910CTTRS	8300100291	3-200-240	50/60	1,070	2,600	7.9	-40...+60
	VWA0910CTTRS	8300100248	3-380-480	50/60	1,130	2,950	4.5	-40...+60
	VWA0910CTTRS	8300100274	3-380-480	50/60	1,320	4,750	7.4	-40...+60

Subject to technical changes. <sup>(1)</sup> Nominal data at operating point with maximum load and 230 VAC or 480 VAC. Values are measured with a guard grill.

Airflow direction

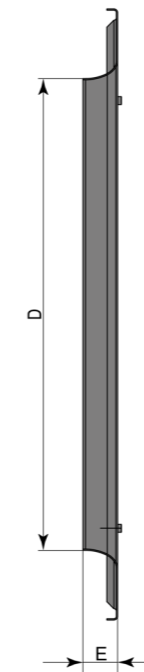
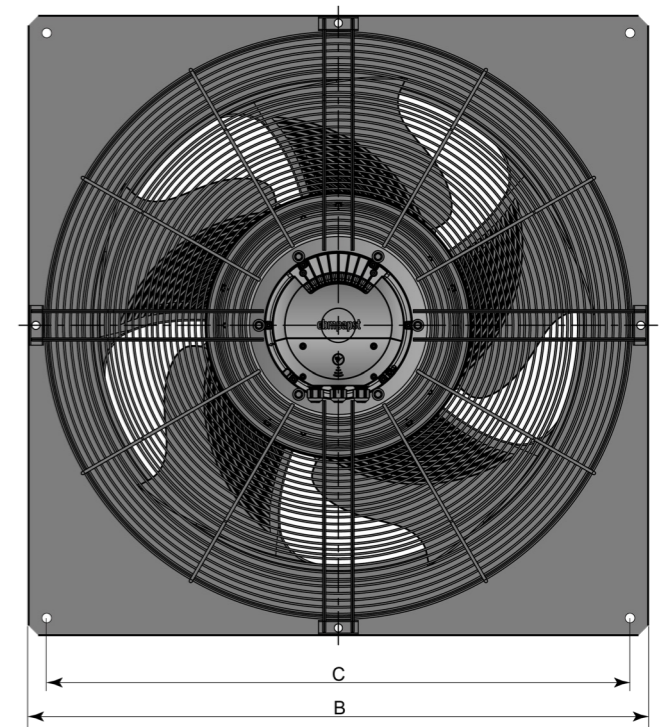
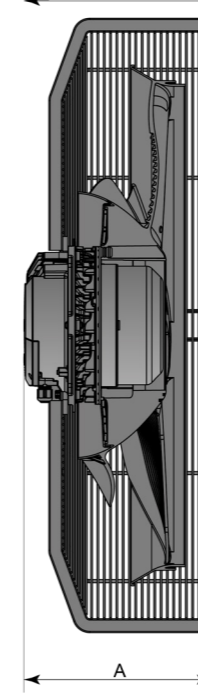

## Dimensions

Size	Type	Material number	Motor	Inlet ring article number	A	B	C	D	E
630	VWA0630CSRLS	8300100196	EC		322				
	VWA0630CTRNS	8300100195	EC	60630-2-4013	322	805	750 mm, 4 x Ø 11 mm	595	53
	VWA0630CTTLS	8300100293	EC		290				
	VWA0630CTTRS	8300100237	EC		290				
800	VWA0800CSRLS	8300100231	EC		336				
	VWA0800CTRNS	8300100230	EC	60800-2-4013	336	970	910 mm, 4 x Ø 14.5 mm	749	55
	VMA0800CTTLS	8300100240	EC		303				
	VMA0800CTTPS	8300100253	EC		303				
	VWA0800CTTRS	8300100292	EC		332				
	VWA0800CTTRS	8300100272	EC		332				
910	VWA0910CSRLS	8300100236	EC		375				
	VWA0910CTRNS	8300100234	EC	60910-2-4013	375	1,070*1	1,010 mm, 4 x Ø 14.5 mm	841	67
	VMA0910CTTLS	8300100251	EC		340				
	VWA0910CTTRS	8300100291	EC		340				
	VWA0910CTTRS	8300100248	EC		340				
VWA0910CTTRS	8300100274	EC		373					

Subject to technical changes. All dimensions in mm. Data sheets available on request.

\*1 Basket guard grill version Ø 1,075

# AxiEco without fan housing.

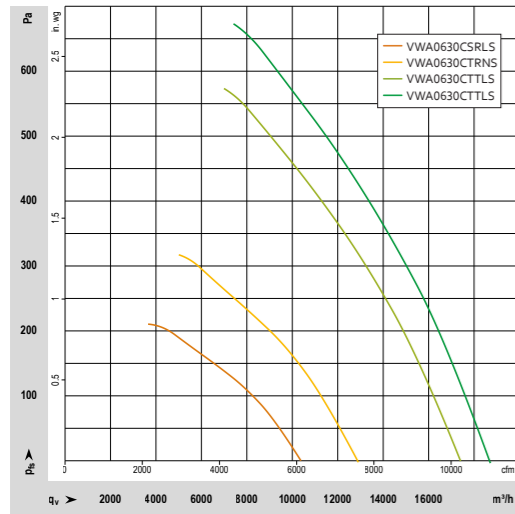

Characteristic curve field for size 630

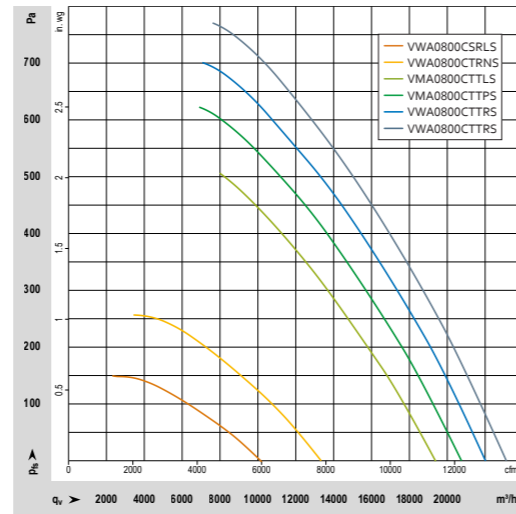

Characteristic curve field for size 800

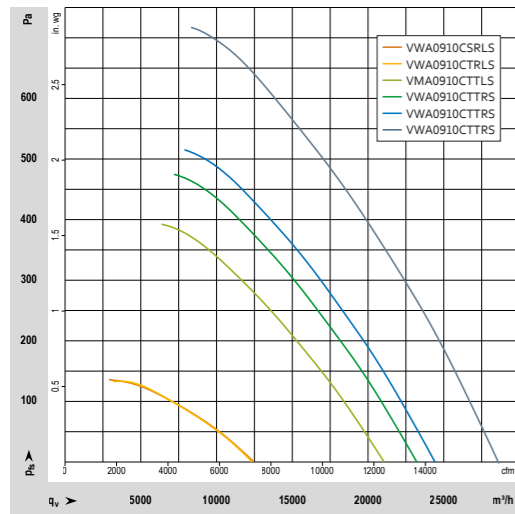

Characteristic curve field for size 910

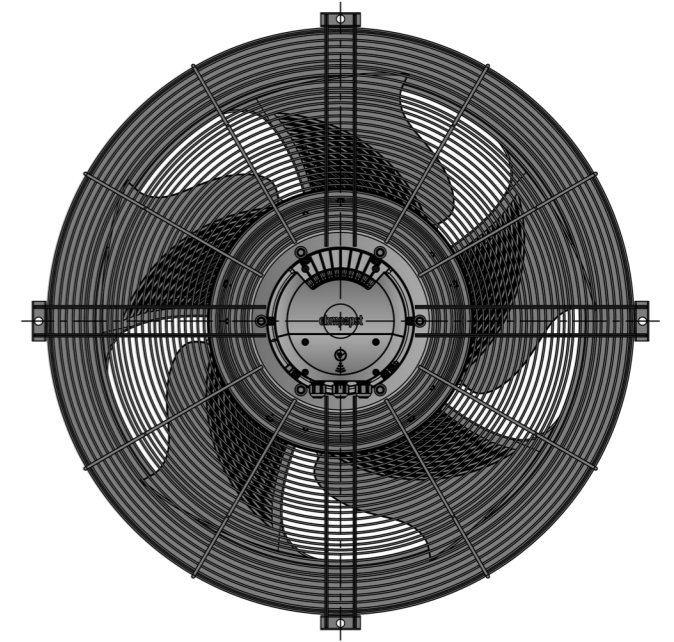
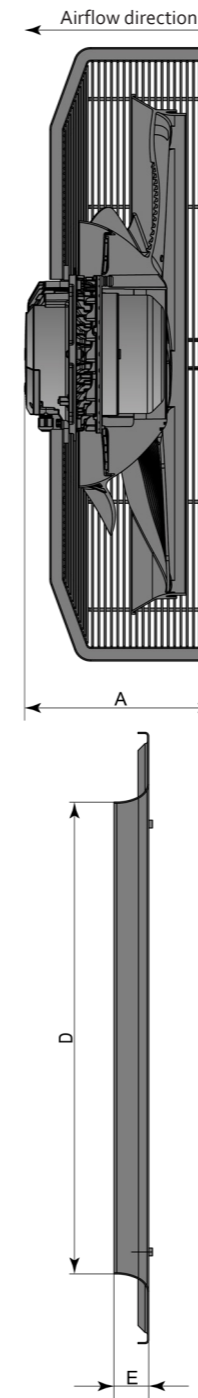

Nominal data			Nominal voltage range	Frequency	Speed <sup>(1)</sup>	Max. power consumption <sup>(2)</sup>	Max. input current <sup>(1)</sup>	Permiss. ambient temp.
Size	Type	Material number	V AC	Hz	rpm	W	A	°C
630	VMA0630CTTLS	8300100235*	3-380-480	50/60	1,820	3,400	5.2	-40...+60
	VMA0800CTTLS	8300100238*	3-380-480	50/60	1,270	2,500	3.9	-40...+60
800	VMA0800CTTPS	8300100254*	3-380-480	50/60	1,370	3,150	4.8	-40...+60
	VWA0800CTTRS	8300100273*	3-380-480	50/60	1,520	4,300	6.8	-40...+60
910	VMA0910CTTLS	8300100252*	3-380-480	50/60	970	2,000	3.1	-40...+60
	VWA0910CTTRS	8300100250*	3-380-480	50/60	1,130	2,950	4.5	-40...+60
	VWA0910CTTRS	8300100275*	3-380-480	50/60	1,320	4,750	7.4	-40...+60

Subject to technical changes. <sup>(1)</sup> Nominal data at operating point with maximum load and 230 VAC or 480 VAC. Values are measured with a guard grill. \* supplied without fan housing, only as basket guard grill version

## Dimensions

Size	Type	Material number	Motor	Inlet ring article number	A	B	C	D	E
630	VMA0630CTTLS	8300100235*	EC	60630-2-4013	288	805	750 mm, 4 x Ø 11 mm	595	53
	VMA0800CTTLS	8300100238*	EC		301				
800	VMA0800CTTPS	8300100254*	EC	60800-2-4013	301	970	910 mm, 4 x Ø 14.5 mm	749	55
	VWA0800CTTRS	8300100273*	EC		330				
910	VMA0910CTTLS	8300100252*	EC		338				
	VWA0910CTTRS	8300100250*	EC	60910-2-4013	338	1,070* <sup>1</sup>	1,010 mm, 4 x Ø 14.5 mm	841	67
	VWA0910CTTRS	8300100275*	EC		371				

Subject to technical changes. All dimensions in mm. Data sheets available on request. \* supplied without fan housing, only as basket guard grill version <sup>1</sup> Basket guard grill version Ø 1,075

# GreenIntelligence. Making Engineers Happy.



Why do our customers look so happy? Because when it comes to digitalization and sustainability, we provide them with a clear competitive edge with GreenIntelligence. The intelligent control and networking of fans and drives makes applications more powerful and efficient. Together with a long product life and highly efficient EC technology, we achieve lasting reductions in energy costs and emissions.

Our intelligent technologies combine high-efficiency ventilation and drive technology with sophisticated sensors and high-performance electronics – for everything from data collection and transmission through to server/cloud connection and data evaluation with application-specific algorithms. Together, we will develop the solution that sustainably lowers costs, saves energy and reduces emissions, whether that's demand-based operation, simple remote monitoring, or predictive maintenance. In this way, we can extend the service life of products and systems, reduce current consumption by up to 70 % and help shrink your carbon footprint. Finally, we also improve conditions in living and working environments and help to increase the quality of indoor air.

## Here is how much GreenIntelligence there is in AxiEco:

- + Connection to higher-level communication points possible
- + Control system optimally adapted to the needs of the system
- + Constantly efficient cooling capacity



# ebm-papst. Engineering a better life.

## Who we are.

With over 20,000 different products, ebm-papst offers the right solution for just about any challenge. As the logical next stage in the development of our highly-efficient GreenTech EC technology, we believe that industrial digitization offers the greatest future prospects for our customers. With GreenIntelligence, we already represent intelligently interconnected complete solutions that are unrivaled worldwide.

Because we are always committed to making each of our innovative hardware and software solutions more powerful, compact, efficient and sustainable than its predecessor, we have evolved over the years into the global technology leader for ventilation and drive technology.

## What drives us.

But our consistent pursuit of efficiency and progress has even deeper roots. After all, there is something that excites us even more than our market position. It is the deep awareness that, with our solutions, like the AxiEco, we are making the lives of many people around the globe more pleasant, safer and thus better. Therefore, the central driving force in all our thoughts and actions is Engineering a better life. It is the reason why it is worthwhile for us to get up every day and do our best.

More about this under [ebmpapst.com/betterlife](https://ebmpapst.com/betterlife)

**ebmpapst**

engineering a better life

## What you get out of it.

- 1. Technological edge.**  
With our EC technology and GreenIntelligence, we combine the highest energy efficiency with the advantages of IoT and digital networking.
- 2. Our sustainable approach.**  
We take our responsibility seriously with energy-saving products, environmentally-friendly processes and through social engagement.
- 3. System expertise.**  
As experts in advanced motor technology, electronics and aerodynamics, we provide perfect system solutions from a single source.
- 4. The ebm-papst spirit of invention.**  
Over 800 engineers and technicians will develop a solution that precisely fits your needs.
- 5. Personal proximity to you.**  
Thanks to numerous sales locations worldwide.
- 6. Our standard of quality.**  
Our quality management is uncompromising, at every step and in every process.

Liam uses intelligent and sustainable technologies to optimize his applications and save time and money.

GreenIntelligence helps us turn our commitment to *Engineering a better life* into reality.

What exactly does this mean? Watch the video now:





## How to reach us.

Let's find out how ebm-papst can help to make your company and your solutions even better.

[www.ebmpapst.com](http://www.ebmpapst.com)

**ebmpapst**

engineering a better life



**ebm-papst**  
Muldingen GmbH & Co. KG

Bachmühle 2  
74673 Muldingen  
Germany  
Phone +49 7938 81-0  
Fax +49 7938 81-110  
[info1@de.ebmpapst.com](mailto:info1@de.ebmpapst.com)